

LED DOWNLIGHT SPECTRE IP54 TRIAC DIM

KEY FEATURES

- CCT Switchable
- Lifetime 50,000 hours
- Included driver with fast-connector
- Very quick and easy installation
- Triac dimming
- Excellent price-quality ratio
- Energy savings up to 50%
- Also applicable for humidity atmosphere
- 5 year Pragmalux Warranty

APPLICATIONS



SPECIFICATIONS

Item code	Description	W	lm	lm/W	Kelvin	CRI	Input current	Lifetime L80B10	Beam angle
4608167	LED Downlight Spectre SR IP54 13W 3000K-5700K 3-CCT Ø145 Cutout Ø125-135mm Triac Dimmable	13	1120-1310	86-101	3000/4000/5700	≥80	0.07	50,000	90°
4608174	LED Downlight Spectre SR IP54 18W 3000K-5700K 3-CCT Ø172 Cutout Ø150-165mm Triac Dimmable	18	1800-1980	100-110	3000/4000/5700	≥80	0.09	50,000	90°
4608181	LED Downlight Spectre SR IP54 25W 3000K-5700K 3-CCT Ø228 Cutout Ø200-210mm Triac Dimmable	25	2500-2750	100-110	3000/4000/5700	≥80	0.12	50,000	90°

TECHNICAL DATA

Electrical data	
Voltage (V)	220-240
Frequency (Hz)	50/60
Power factor (λ)	≥0.9
Operating mode	External LED Driver
Electrical connection	Max 2x2.5mm ² wire
Total harmonic distortion	≤ 20 %

Certificates & standards	
Driver certificates	CE
Fixture certificates	CE
Ingress protection	IP54
Protection class	II
Protection class IK	IK06
Glow Wire Test (IEC 695-2-1)	650°C
Photobiological safety group EN62778	RG0

LED DOWNLIGHT SPECTRE IP54 TRIAC DIM

Temperatures & operating conditions

Ambient temperature	25°C
Operating temperature	-20 ~ +40°C
Storage temperature	-20 ~ +65°C

Colors & materials

Color (Housing)	White RAL9016
Material (Housing)	PC
Material (Diffuser)	PC
Material (Reflector)	Aluminum

Capabilities

UGR	≤22
Dimmable	Yes, Triac
Type of connection	Push Terminal, 2-pole
LED Module replacable	No
Installation	CCT Switchable

SPECIFICATIONS DRIVERS

Item code	Description	Driver failure rate at 5,000h	Inrush current Ipeak (A)	Inrush current Twidth (µs)	Max. No. of drivers on MCB Type							
					B 10A	B 13A	B 16A	B 20A	C 10A	C 13A	C 16A	C 20A
4608167	LED Downlight Spectre SR IP54 13W 3000K-5700K 3-CCT Ø145 Cutout Ø125-135mm Triac Dimmable	≤1%	2.18	135	83	108	138	167	83	108	138	167
4608174	LED Downlight Spectre SR IP54 18W 3000K-5700K 3-CCT Ø172 Cutout Ø150-165mm Triac Dimmable	≤1%	3.06	224	48	62	76	95	48	62	76	95
4608181	LED Downlight Spectre SR IP54 25W 3000K-5700K 3-CCT Ø228 Cutout Ø200-210mm Triac Dimmable	≤1%	4.64	224	33	43	53	67	33	43	53	67

DIMENSIONS

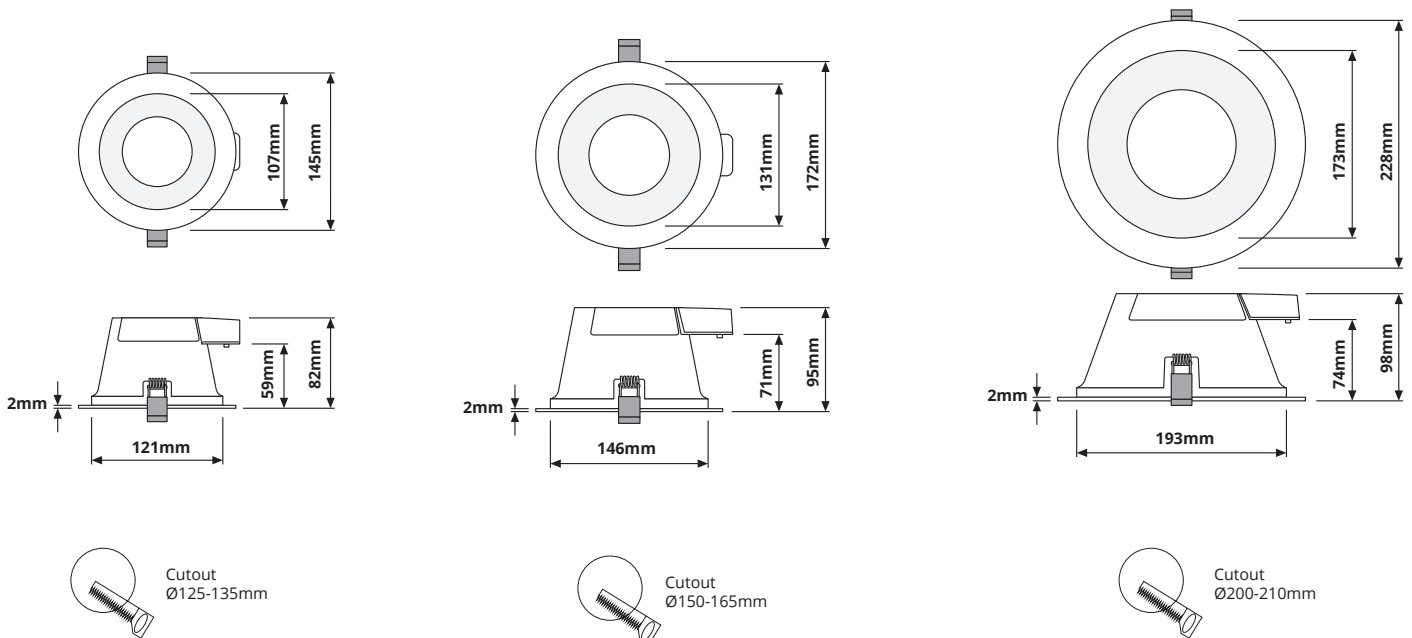

PRAGMALUX

All rights reserved. Pragmalux - PDL Lighting Group B.V. retains the right to modify product specifications without any prior notice or obligation and does not assume any liability for any consequences of using this document. Subject to errors and printing errors. Luminous flux tolerance: +/- 10%. Power consumption tolerance: +/- 10%.

Version: May 2020

Page 2/4

LED DOWNLIGHT SPECTRE IP54 TRIAC DIM

PRODUCT DETAILS

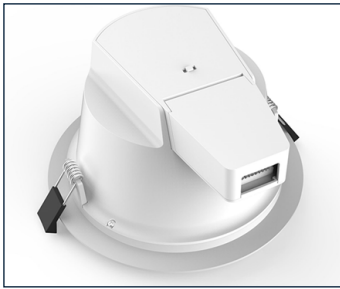

Detail 1

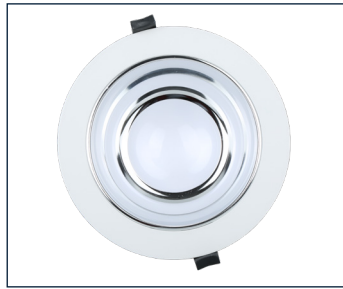

Detail 2

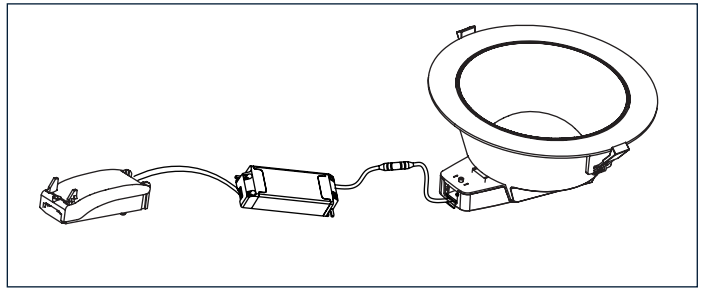

Detail 3

PHOTOMETRIC SPECIFICATIONS

LED Downlight Spectre SR IP54 13W 3000K

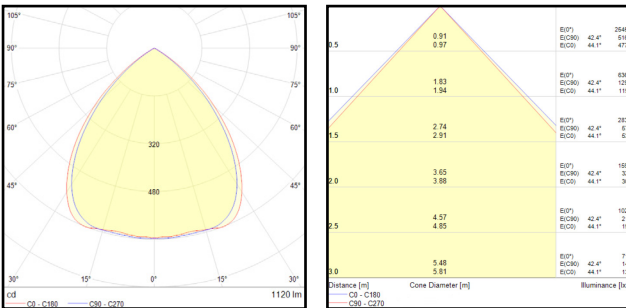

LED Downlight Spectre SR IP54 13W 4000K

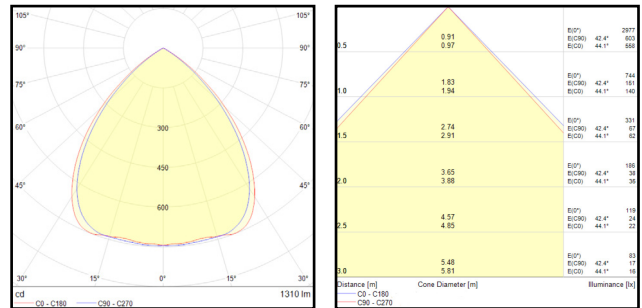

LED Downlight Spectre SR IP54 13W 5700K

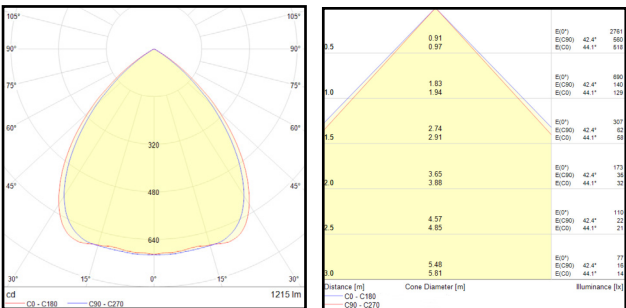

LED Downlight Spectre SR IP54 18W 3000K

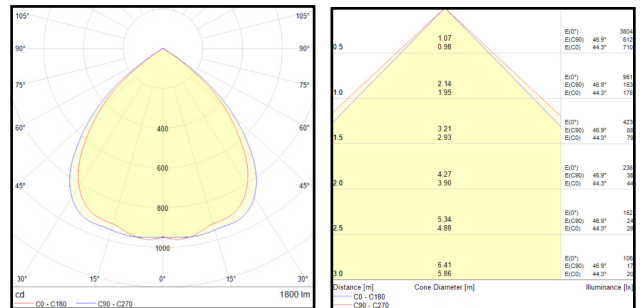

LED Downlight Spectre SR IP54 18W 4000K

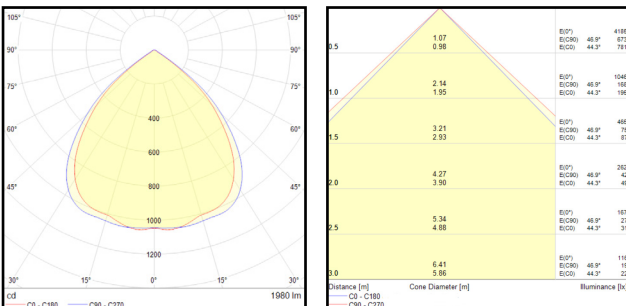

LED Downlight Spectre SR IP54 18W 5700K

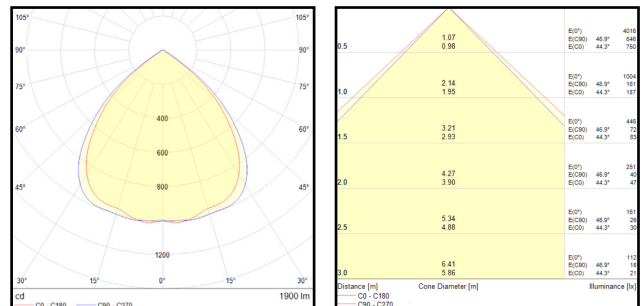

PRAGMALUX

All rights reserved. PragmaLux - PDL Lighting Group B.V. retains the right to modify product specifications without any prior notice or obligation and does not assume any liability for any consequences of using this document. Subject to errors and printing errors. Luminous flux tolerance: +/- 10%. Power consumption tolerance: +/- 10%.

Version: May 2020

LED DOWNLIGHT SPECTRE IP54 TRIAC DIM

LED Downlight Spectre SR IP54 25W 3000K

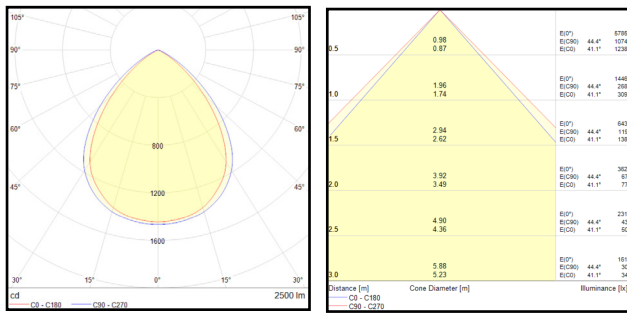

LED Downlight Spectre SR IP54 25W 4000K

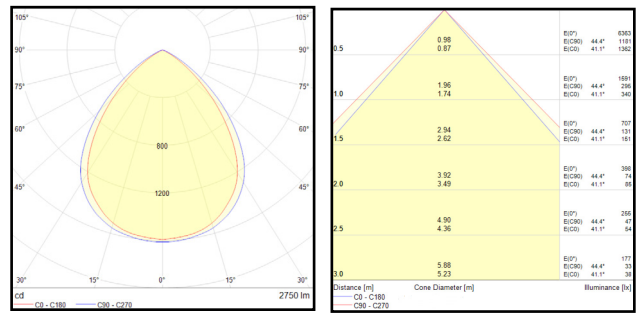

LED Downlight Spectre SR IP54 25W 5700K

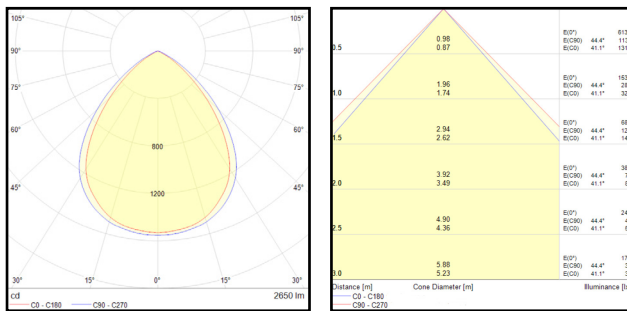

PACKAGING INFORMATION

Item code	Description	Net weight product (g)	Single box		Master carton		
			Dimensions (LxWxH) (mm)	Weight (g)	Units per master carton	Dimensions (LxWxH) (mm)	Weight (g)
4608167	LED Downlight Spectre SR IP54 13W 3000K-5700K 3-CCT Ø145 Cutout Ø125-135mm Triac Dimmable	280	170x170x125	420	24	530x360x520	10080
4608174	LED Downlight Spectre SR IP54 18W 3000K-5700K 3-CCT Ø172 Cutout Ø150-165mm Triac Dimmable	450	195x195x140	700	12	410x410x440	8400
4608181	LED Downlight Spectre SR IP54 25W 3000K-5700K 3-CCT Ø228 Cutout Ø200-210mm Triac Dimmable	650	250x250x140	958	12	520x520x440	11500

APPLICATIONS

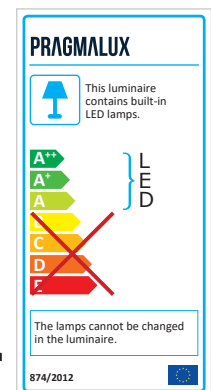

PRAGMALUX

All rights reserved. Pragmalux - PDL Lighting Group B.V. retains the right to modify product specifications without any prior notice or obligation and does not assume any liability for any consequences of using this document. Subject to errors and printing errors. Luminous flux tolerance: +/- 10%. Power consumption tolerance: +/- 10%.

Version: May 2020

Page 4/4